

CITY OF WILLIAMSPORT, PA RESOLUTION

RESOLUTION # 9252

DATE 2-17-22

TITLE

**A RESOLUTION AUTHORIZING THE USE OF ARPA (AMERICAN
RESCUE PLAN ACT) FUNDS TO INSTALL AN UPGRADED
ELECTRICAL PANEL AT MEMORIAL POOL**

BE IT HEREBY RESOLVED that the City Council of the City of Williamsport, authorizes the use of ARPA (American Rescue Plan Act) funds to install an upgraded electrical panel and LED lighting at Memorial Pool.

BE IT FURTHER RESOLVED that the total cost for the materials and installation is not to exceed \$11,989.02.

BE IT FURTHER RESOLVED by the City of Williamsport that the Mayor and City Controller be authorized to sign all documents necessary to carry out the intent of this Resolution.

Approved

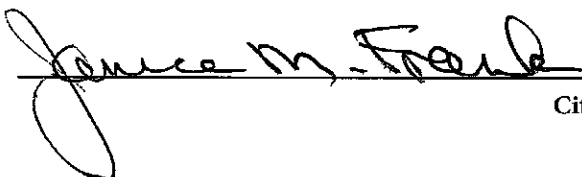

City Clerk



President

Product data sheet
Characteristics

8903LG40V02
Contactor, Type L, multipole lighting,
electrically held, 30A, 4 pole, 600 V, 110/120
VAC 50/60 Hz coil, NEMA 1

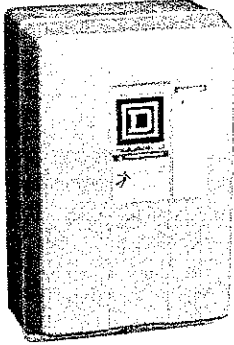

Main

Product or Component Type	Electrically Held Lighting Contactor
Range of Product	8903L
Control Circuit	Separate control circuit

Complementary

Control Circuit Voltage	110 V AC 50 Hz 120 V AC 60 Hz
Inrush power in VA	150 VA 60 Hz 140 VA 50 Hz
Hold-in power consumption in VA	30 VA 60 Hz 30 VA 50 Hz
Current Rating	20 A tungsten 30 A fluorescent
Number of Poles	4P 4 NO
Control Unit	No control units
Pilot Light	No indicator
Electrical Connection	Screw-clamp terminals
Height	12.68 in (322 mm)
Depth	6.02 in (153 mm)
Width	7.80 in (198 mm)
Net Weight	10.10 lb(US) (4.58 kg)

Environment

Enclosure Type	NEMA 1 painted sheet steel surface
Product Certifications	UL Listed CSA

Ordering and shipping details





Category	21321 - 8903 L (NOT LX)
Discount Schedule	CP1
GTIN	785901851325
Nbr. of units in pkg.	1
Package weight(Lbs)	9.87 lb(US) (4.477 kg)
Returnability	Yes
Country of origin	MX

The information provided in this documentation contains general descriptions and/or technical characteristics of the performance of the products contained herein. This documentation is not intended as a substitute for and is not to be used for determining suitability or reliability of these products for specific user applications. It is the duty of any such user or integrator to perform the appropriate and complete risk analysis, evaluation and testing of the products with respect to the relevant specific application or use thereof. Neither Schneider Electric Industries SAS nor any of its affiliates or subsidiaries shall be responsible or liable for misuse of the information contained herein.

Packing Units

Unit Type of Package 1	PCE
Package 1 Height	9.70 in (24.638 cm)
Package 1 width	9.30 in (23.622 cm)
Package 1 Length	15.50 in (39.37 cm)

Offer Sustainability

Sustainable offer status	Green Premium product
REACH Regulation	 REACH Declaration
REACH free of SVHC	Yes
EU RoHS Directive	Compliant  EU RoHS Declaration
Toxic heavy metal free	Yes
Mercury free	Yes
RoHS exemption information	 Yes
China RoHS Regulation	 China RoHS Declaration
Environmental Disclosure	 Product Environmental Profile
PVC free	Yes
Halogen content performance	Halogen free plastic parts product

Contractual warranty

Warranty	18 months
----------	-----------

Approximate Dimensions

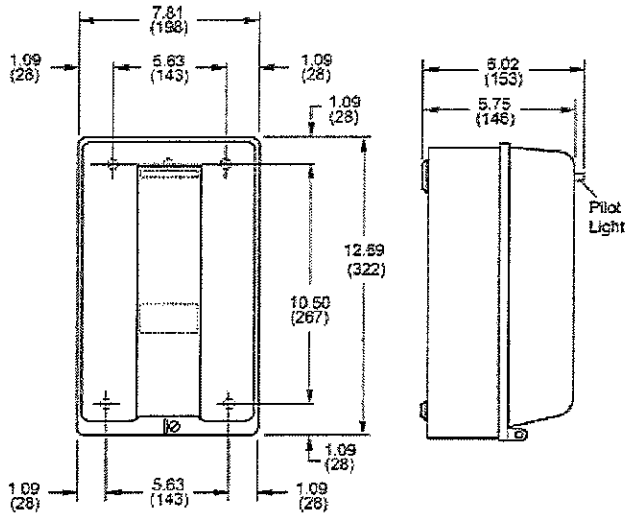



Catalog Number
Notes
Type

Contractor Select™
TFX LED
 Floodlights

The TFX LED floodlights from Lithonia Lighting deliver the best value in lighting, from a brand you can trust. Superior performance and design make this product suitable for any general purpose floodlighting application.

FEATURES:

- Ideal solution to replace up to 1000W metal halide floodlights
- Floodlight pays for itself in less than 2 years
- Robust design and cost effective – ideal for outdoor installations

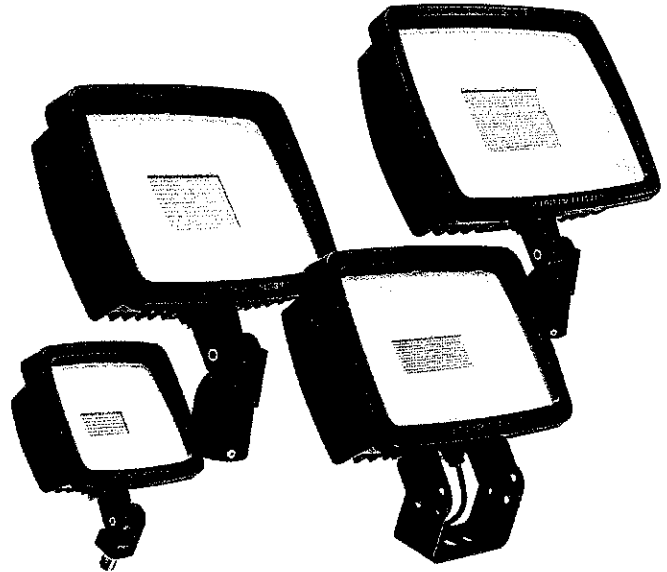

Luminaire	CCT	Lumens	Input Watts	Finish	Voltage	Catalog Number	CI Code	UPC	Pallet qty.	Replaces Up To
TFX1	4000K	7,300	54W	DARK BRONZE	120-277V	TFX1 LED 40K MVOLT THK DDBXD M6	*2552M5	193047670173	180	175W Metal Halide
	4000K	13,200	94W	DARK BRONZE	120-277V	TFX2 LED 40K MVOLT IS DDBXD	*2552MC	193047670241	45	250W Metal Halide
TFX2	4000K	13,200	94W	DARK BRONZE	120-277V	TFX2 LED 40K MVOLT YK DDBXD	*2552ME	193047670234	63	250W Metal Halide
	5000K	13,200	94W	DARK BRONZE	120-277V	TFX2 LED 50K MVOLT YK DDBXD	*2581FK	193048041552	63	250W Metal Halide
TFX3	4000K	25,600	188W	DARK BRONZE	120-277V	TFX3 LED 40K MVOLT IS DDBXD	*2552MF	193047670265	24	400W Metal Halide
	4000K	25,600	188W	DARK BRONZE	120-277V	TFX3 LED 40K MVOLT YK DDBXD	*255MJ	193047670258	36	400W Metal Halide
TFX4	4000K	41,000	296W	DARK BRONZE	120-277V	TFX4 LED 40K MVOLT IS DDBXD	*2552MM	193047670302	12	1000W Metal Halide
	4000K	41,000	296W	DARK BRONZE	120-277V	TFX4 LED 40K MVOLT YK DDBXD	*2552MN	193047670326	12	1000W Metal Halide

More configurations are available. [Click here](#) or visit www.acuitybrands.com and search for TFX LED.

Accessories: Order as separate catalog number.

[Click here](#) to visit [Accessories](#).



Specifications

INTENDED USE:

The traditional and robust design of the TFX LED floodlight with energy efficient LEDs, is suitable for replacing up to 1000W Metal Halide. It is ideal for landscape, signage, and accent lighting in heavy commercial and residential applications.

CONSTRUCTION:

Die-cast aluminum housing has integral heat sink fins to optimize thermal management through conductive and convective cooling. The LED driver is mounted in direct contact with the casting to promote low operating temperature and long life. Housing is completely sealed against moisture and environmental contaminants (IP66). Low EPA for optimized wind loading.

ELECTRICAL:

Light engine(s) consist of LEDs directly coupled to the housing to maximize heat dissipation and promote long life (up to L90 / 100,000 hrs.). TFX LED luminaires use MVOLT (120-277V) electronic drivers that are 0-10V, capable of continuous dimming and ensure system power factor >90% and THD <20%.

INSTALLATION:

The integral slip fitter option (IS) mates with standard 2 3/8" tenons for pole-top mounting. The yoke mount (YK) option allows mounting to solid surfaces and has a 30" SO cord. TFX luminaires are suitable for aiming in any orientation. TFX is rated for installation on ground. Can be tilted from 0° horizontal facing downwards, up to 180° horizontal facing upwards.

LISTINGS:

UL certified to U.S. and Canadian standards. Luminaire is IP66 rated. Rated for -40°C minimum ambient.

DesignLights Consortium® (DLC) Premium qualified product and DLC qualified product. Not all versions of this product may be DLC Premium qualified or DLC qualified. Please check the DLC Qualified Products List at www.designlights.org/OPL to confirm which versions are qualified.

WARRANTY:

5-year limited warranty. Complete warranty terms located at: www.acuitybrands.com/support/warranty/terms-and-conditions

Note: Actual performance may differ as a result of end-user environment and application. All values are design or typical values, measured under laboratory conditions at 25 °C. Specifications subject to change without notice.

Dimensions

All dimensions are inches (centimeters) unless otherwise indicated.

TFX1

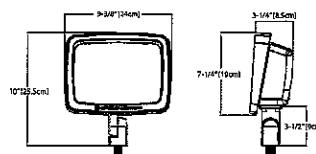

TFX1 with Knuckle Mount

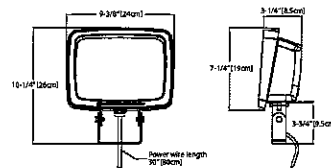

TFX1 with Yoke Mount

TFX2

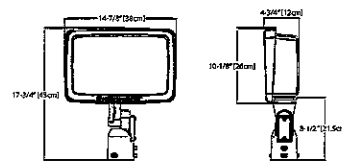

TFX2 with Integral Slip-Fitter

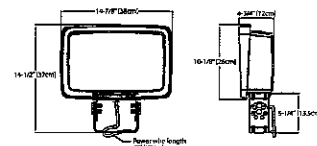

TFX2 with Yoke Mount

TFX3

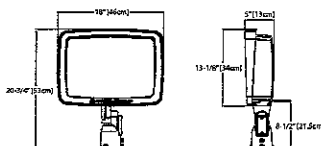

TFX3 with Integral Slip-Fitter

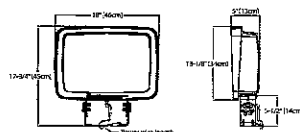

TFX3 with Yoke Mount

TFX4

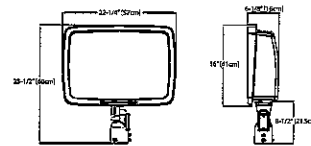

TFX4 with Integral Slip-Fitter

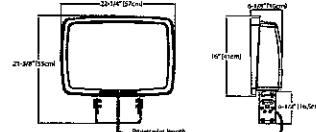

TFX4 with Yoke Mount



TFX1 - Luminaire EPA

*Includes luminaire and integral mounting arm.
Other tenons, arms, brackets or other accessories are not included in this EPA data.

TFX1 LED	
Angle of Tilt	EPA (ft2)
0°	0.29
10°	0.34
20°	0.39
30°	0.42
40°	0.45
50°	0.47
60°	0.48
70°	0.50
80°	0.50
90°	0.50

TFX2 - Luminaire EPA

*Includes luminaire and integral mounting arm.
Other tenons, arms, brackets or other accessories are not included in this EPA data.

TFX2 LED	
Angle of Tilt	EPA (ft2)
0°	0.62
10°	0.64
20°	0.76
30°	0.87
40°	0.96
50°	1.02
60°	1.07
70°	1.08
80°	1.10
90°	1.12

TFX3 - Luminaire EPA

*Includes luminaire and integral mounting arm.
Other tenons, arms, brackets or other accessories are not included in this EPA data.

TFX3 LED	
Angle of Tilt	EPA (ft2)
0°	0.79
10°	0.93
20°	1.14
30°	1.31
40°	1.43
50°	1.56
60°	1.63
70°	1.71
80°	1.75
90°	1.72

TFX4 - Luminaire EPA

*Includes luminaire and integral mounting arm.
Other tenons, arms, brackets or other accessories are not included in this EPA data.

TFX4 LED	
Angle of Tilt	EPA (ft2)
0°	1.18
10°	1.38
20°	1.68
30°	1.94
40°	2.14
50°	2.37
60°	2.46
70°	2.52
80°	2.57
90°	2.58



Lecce Electric, Inc.

1843 Liberty Dr.
Williamsport, PA 17701
(570) 494-1750 Phone
(570) 494-1754 Fax

December 8, 2021

Williamsport Streets & Parks
1550 West Third Street
Williamsport, PA 17701

Attn: Kevin Early

Project: Memorial Pool Electrical Service Grounding

Kevin,

We have provided the material and labor necessary to install and test a counterpoise ground system for the electrical service at Memorial Pool.

Total Cost Not-To-Exceed: \$1,350.00 (One Thousand Three Hundred Fifty Dollars)

Notes:

- 1) All excavation, backfill, and restoration is by others.

If you have any questions, or if we can be of any other service to you, please don't hesitate to call.

If you would like to accept this quote please sign it and return it to me or provide your purchase order for this work.

Best regards,

Kenneth W. Getz
Estimator / Project Coordinator



FULLY EXECUTED

Contract Number: 4400024776

Original Contract Effective Date: 07/22/2021

Valid From: 07/20/2021 To: 10/31/2022

All using Agencies of the Commonwealth, Participating Political
Subdivision, Authorities, Private Colleges and Universities

Purchasing Agent

Name: Peek Lilly

Phone: 717-346-3846

Fax: 717-783-6241

Your SAP Vendor Number with us: 533940

Supplier Name/Address:

MAYER ELECTRIC SUPPLY COMPANY INC

DBA THE HITE COMPANY

P.O. Box 1807

ALTOONA PA 16603-1807 US

Please Deliver To:

To be determined at
the time of the Purchase Order
unless specified below.

Supplier Phone Number: 814-944-6121

Supplier Fax Number: 8149442050

Contract Name:

Facility Maint. MRO ITQ

Payment Terms

NET 30

Solicitation No.:

Issuance Date:

Supplier Bid or Proposal No. (if applicable):

Solicitation Submission Date:

This contract is comprised of: The above referenced Solicitation, the Supplier's Bid or Proposal, and any documents attached to this Contract or incorporated by reference.

Item	Material/Service Desc	Qty	UOM	Price	Per Unit	Total
1	Industrial, Electr. Equip&Parts	0.000		0.00	1	0.00

General Requirements for all Items:

No further information for this Contract

Information:

Supplier's Signature _____

Title _____

Printed Name _____

Date _____